

P4KE Series

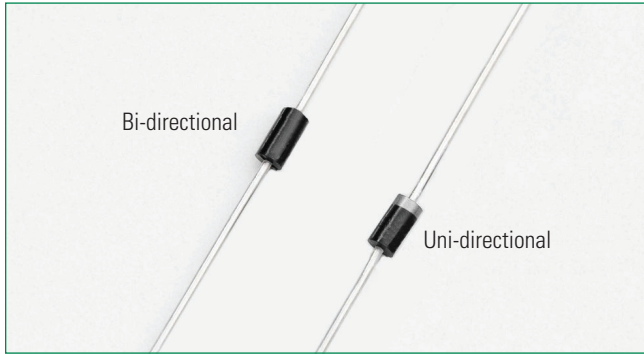

Agency Approvals

Agency	Agency File Number
	E230531

Maximum Ratings and Thermal Characteristics (T_A=25°C unless otherwise noted)

Parameter	Symbol	Value	Unit
Peak Pulse Power Dissipation(Fig.2) by 10/1000us Test Waveform(Fig.4) (Note 1) -Single Die Parts	P _{PPM}	400	W
Peak Pulse Power Dissipation(Fig.2) by 10/1000us Test Waveform(Fig.4) (Note 1) -Stacked Die Parts (Note 4)	P _{PPM}	600	W
Steady State Power Dissipation on Infinite Heat Sink at T _L =75°C	P _D	1.5	W
Peak Forward Surge Current, 8.3ms Single Half Sine Wave Unidirectional Only (Note 2)	I _{FSM}	60	A
Maximum Instantaneous Forward Voltage at 25A for Unidirectional Only (Note 3)	V _F	3.5/5.0	V
Operating Junction and Storage Temperature Range	T _J , T _{STG}	-55 to 175	°C
Typical Thermal Resistance Junction to Lead	R _{θJL}	60	°C/W
Typical Thermal Resistance Junction to Ambient	R _{θJA}	100	°C/W

- Notes:**
1. Non-repetitive current pulse , per Fig. 4 and derated above T_J (initial) =25°C per Fig. 3.
 2. Measured on 8.3ms single half sine wave or equivalent square wave, duty cycle=4 per minute maximum.
 3. V_F < 3.5V for single die parts and V_F < 5.0V for stacked-die parts.
 4. For stacked die component details, please refer to part numbers labeled by * in Electrical Characteristics.

Functional Diagram

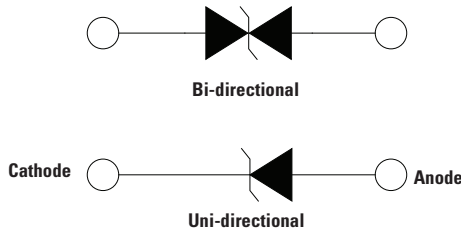

Description

The P4KE Series is designed specifically to protect sensitive electronic equipment from EFTs, ESD, and induced lightning transients.

Features

- 400W peak pulse capability at 10/1000µs waveform, repetition rate (duty cycles):0.01%
- Glass passivated chip junction in DO-41 Package
- Fast response time: typically less than 1.0ps from 0 Volts to V_{BR} min
- Excellent clamping capability
- Typical failure mode is a short circuit
- Whisker test is conducted per Table 4a/4c of JEDEC JESD201A
- IEC 61000-4-2 ESD 30kV(Air), 30kV (Contact)
- EFT protection of data lines in accordance with IEC 61000-4-4
- Low incremental surge resistance
- Typical IR ≤ 1 µA for VBR min > 12.6 V
- High temperature reflow soldering guaranteed: 260°C/30sec / 0.375”(9.5mm) lead length, 5 lbs., (2.3kg) tension
- V_{BR} @ T_J = V_{BR} @ 25°C x (1+αT x (T_J - 25)) (αT: Temperature Coefficient, typical value is 0.1%)
- UL Recognized compound meeting flammability rating V-0
- Halogen free and RoHS compliant
- Pb-free E3 means 2nd level interconnect is Pb-free and the terminal finish material is tin(Sn) (IPC/ JEDEC J-STD-609A.01)

Applications

TVS components are ideal for the protection of I/O interfaces, V_{CC} bus and other vulnerable circuits used in telecom, computer, industrial ICT equipment and consumer electronic applications.

Additional Infomation



Datasheet



Resources



Samples

Electrical Characteristics (T_A=25°C unless otherwise noted)

Part Number (Uni)	Part Number (Bi)	Reverse Stand off Voltage V _R (Volts)	Breakdown Voltage V _{BR} @ I _T (V)		Test Current I _T (mA)	Maximum Clamping Voltage V _C @ I _{PP} (V)	Maximum Peak Pulse Current I _{PP} (A)	Maximum Reverse Leakage I _R @ V _R (μA)	Agency Approval 
			Min.	Max.					
P4KE6.8A	P4KE6.8CA	5.80	6.45	7.14	10	10.5	39.00	1000	X
P4KE7.5A	P4KE7.5CA	6.40	7.13	7.88	10	11.3	36.30	500	X
P4KE8.2A	P4KE8.2CA	7.02	7.79	8.61	10	12.1	33.90	200	X
P4KE9.1A	P4KE9.1CA	7.78	8.65	9.55	1	13.4	30.60	50	X
P4KE10A	P4KE10CA	8.55	9.50	10.50	1	14.5	28.30	10	X
P4KE11A	P4KE11CA	9.40	10.50	11.60	1	15.6	26.30	5	X
P4KE12A	P4KE12CA	10.20	11.40	12.60	1	16.7	24.60	5	X
P4KE13A	P4KE13CA	11.10	12.40	13.70	1	18.2	22.50	1	X
P4KE15A	P4KE15CA	12.80	14.30	15.80	1	21.2	19.30	1	X
P4KE16A	P4KE16CA	13.60	15.20	16.80	1	22.5	18.20	1	X
P4KE18A	P4KE18CA	15.30	17.10	18.90	1	25.5	16.10	1	X
P4KE20A	P4KE20CA	17.10	19.00	21.00	1	27.7	14.80	1	X
P4KE22A	P4KE22CA	18.80	20.90	23.10	1	30.6	13.40	1	X
P4KE24A	P4KE24CA	20.50	22.80	25.20	1	33.2	12.30	1	X
P4KE27A	P4KE27CA	23.10	25.70	28.40	1	37.5	10.90	1	X
P4KE30A	P4KE30CA	25.60	28.50	31.50	1	41.4	9.90	1	X
P4KE33A	P4KE33CA	28.20	31.40	34.70	1	45.7	9.00	1	X
P4KE36A	P4KE36CA	30.80	34.20	37.80	1	49.9	8.20	1	X
P4KE39A	P4KE39CA	33.30	37.10	41.00	1	53.9	7.60	1	X
P4KE43A	P4KE43CA	36.80	40.90	45.20	1	59.3	6.90	1	X
P4KE47A	P4KE47CA	40.20	44.70	49.40	1	64.8	6.30	1	X
P4KE51A	P4KE51CA	43.60	48.50	53.60	1	70.1	5.80	1	X
P4KE56A	P4KE56CA	47.80	53.20	58.80	1	77.0	5.30	1	X
P4KE62A	P4KE62CA	53.00	58.90	65.10	1	85.0	4.80	1	X
P4KE68A	P4KE68CA	58.10	64.60	71.40	1	92.0	4.50	1	X
P4KE75A	P4KE75CA	64.10	71.30	78.80	1	103.0	4.00	1	X
P4KE82A	P4KE82CA	70.10	77.90	86.10	1	113.0	3.60	1	X
P4KE91A	P4KE91CA	77.80	86.50	95.50	1	125.0	3.30	1	X
P4KE100A	P4KE100CA	85.50	95.00	105.00	1	137.0	3.00	1	X
P4KE110A	-	94.00	105.00	116.00	1	152.0	2.70	1	X
-	P4KE110CA*	94.00	105.00	116.00	1	152.0	4.00	1	X
P4KE120A	-	102.00	114.00	126.00	1	165.0	2.50	1	X
-	P4KE120CA*	102.00	114.00	126.00	1	165.0	3.70	1	X
P4KE130A	-	111.00	124.00	137.00	1	179.0	2.30	1	X
-	P4KE130CA*	111.00	124.00	137.00	1	179.0	3.40	1	X
P4KE150A	-	128.00	143.00	158.00	1	207.0	2.00	1	X
-	P4KE150CA*	128.00	143.00	158.00	1	207.0	2.90	1	X
P4KE160A	-	136.00	152.00	168.00	1	219.0	1.90	1	X
-	P4KE160CA*	136.00	152.00	168.00	1	219.0	2.80	1	X
P4KE170A	-	145.00	162.00	179.00	1	234.0	1.80	1	X
-	P4KE170CA*	145.00	162.00	179.00	1	234.0	2.60	1	X
P4KE180A	-	154.00	171.00	189.00	1	246.0	1.70	1	X
-	P4KE180CA*	154.00	171.00	189.00	1	246.0	2.50	1	X
P4KE200A	-	171.00	190.00	210.00	1	274.0	1.50	1	X
-	P4KE200CA*	171.00	190.00	210.00	1	274.0	2.20	1	X
P4KE220A	-	185.00	209.00	231.00	1	328.0	1.30	1	-
-	P4KE220CA*	185.00	209.00	231.00	1	328.0	1.90	1	-
P4KE250A	-	214.00	237.00	263.00	1	344.0	1.20	1	-
-	P4KE250CA*	214.00	237.00	263.00	1	344.0	1.80	1	-
P4KE300A	-	256.00	285.00	315.00	1	414.0	1.00	1	-
-	P4KE300CA*	256.00	285.00	315.00	1	414.0	1.50	1	-
P4KE350A*	P4KE350CA*	300.00	332.00	368.00	1	482.0	1.30	1	-
P4KE400A*	P4KE400CA*	342.00	380.00	420.00	1	548.0	1.10	1	-
P4KE440A*	P4KE440CA*	376.00	418.00	462.00	1	602.0	1.00	1	-
P4KE480A*	P4KE480CA*	408.00	456.00	504.00	1	658.0	0.92	1	-
P4KE510A*	P4KE510CA*	434.00	485.00	535.00	1	698.0	0.86	1	-
P4KE530A*	P4KE530CA*	451.00	503.50	556.50	1	725.0	0.83	1	-
P4KE540A*	P4KE540CA*	460.00	513.00	567.00	1	740.0	0.82	1	-
P4KE550A*	P4KE550CA*	468.00	522.50	577.50	1	760.0	0.79	1	-

For bidirectional type having V_R of 10 volts and less, the I_R value is double.

For parts without A, the V_{BR} is ± 10% and V_C is 5% higher than with A parts, the parts without A are currently available, but not recommended for new designs. The parts with A are preferred.

For stack-die parts, use * to label the part number.

I-V Curve Characteristics

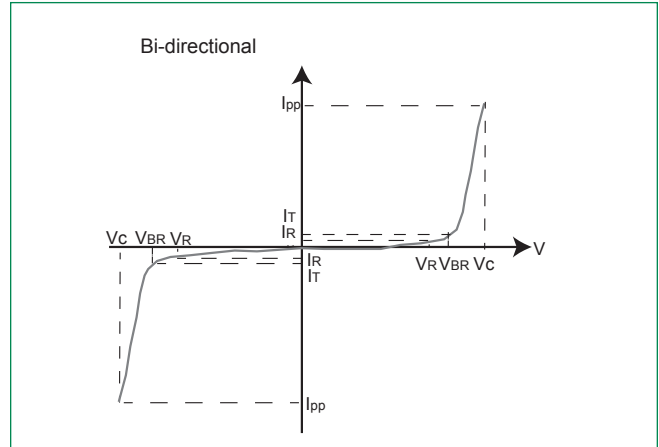
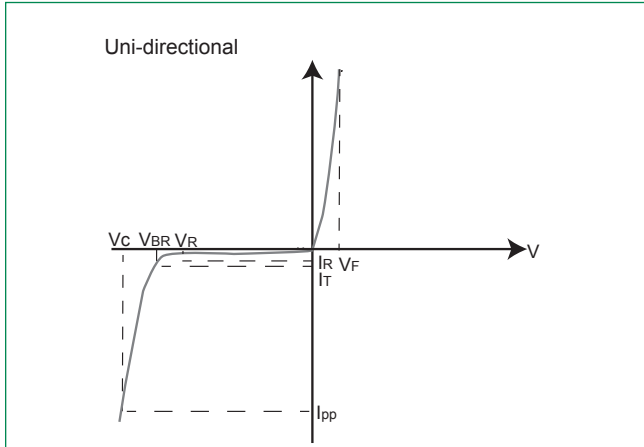

- P_{PPM}** Peak Pulse Power Dissipation – Max power dissipation
- V_R** Stand-off Voltage – Maximum voltage that can be applied to the TVS without operation
- V_{BR}** Breakdown Voltage – Maximum voltage that flows through the TVS at a specified test current (I_T)
- V_C** Clamping Voltage – Peak voltage measured across the TVS at a specified I_{ppm} (peak impulse current)
- I_R** Reverse Leakage Current – Current measured at V_R
- V_F** Forward Voltage Drop for Uni-directional

Ratings and Characteristic Curves (T_A=25°C unless otherwise noted)

Figure 1 - TVS Transients Clamping Waveform

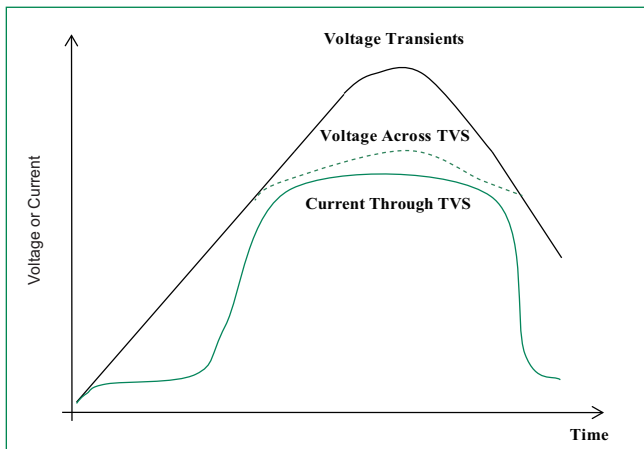
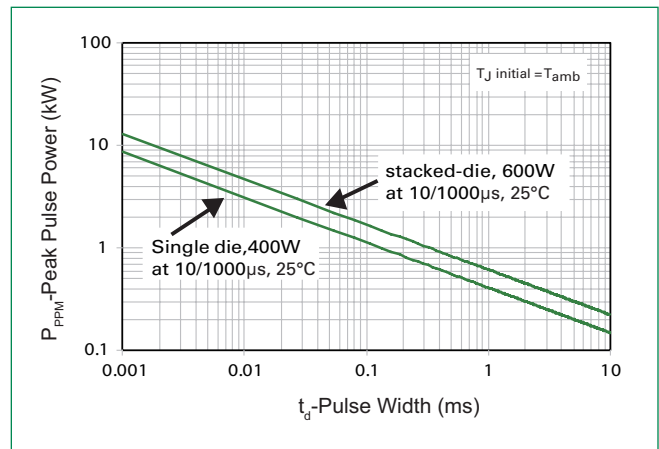

Figure 2 - Peak Pulse Power Rating Curve



Ratings and Characteristic Curves ($T_A=25^{\circ}\text{C}$ unless otherwise noted) (Continued)

Figure 3 - Peak Pulse Power Derating Curve

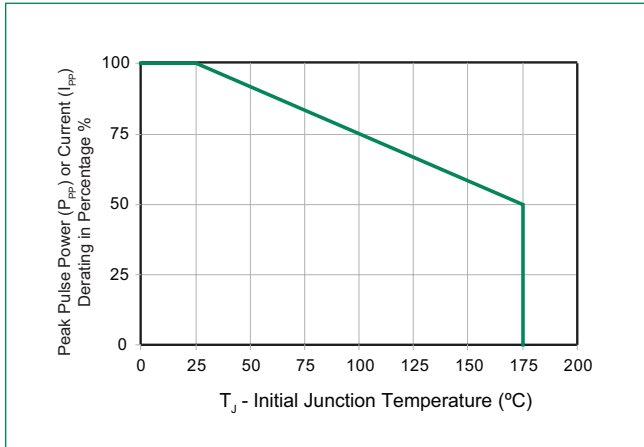

Figure 4 - Pulse Waveform

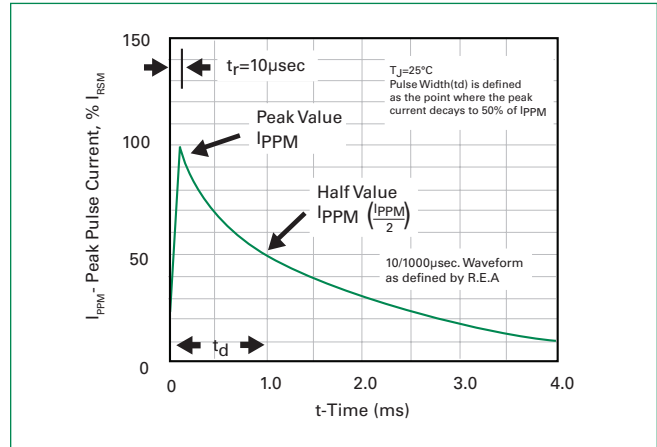

Figure 5 - Typical Junction Capacitance

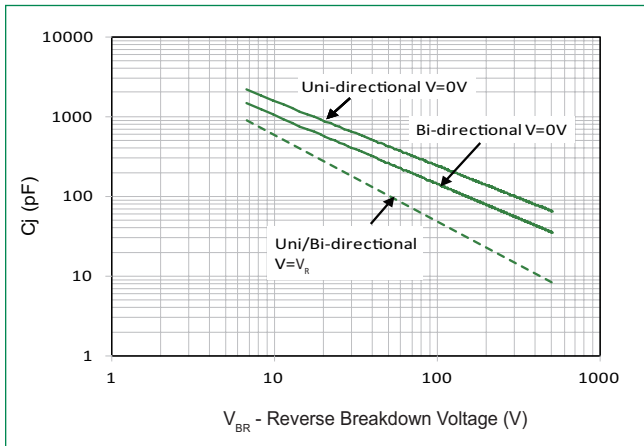

Figure 6 - Typical Transient Thermal Impedance

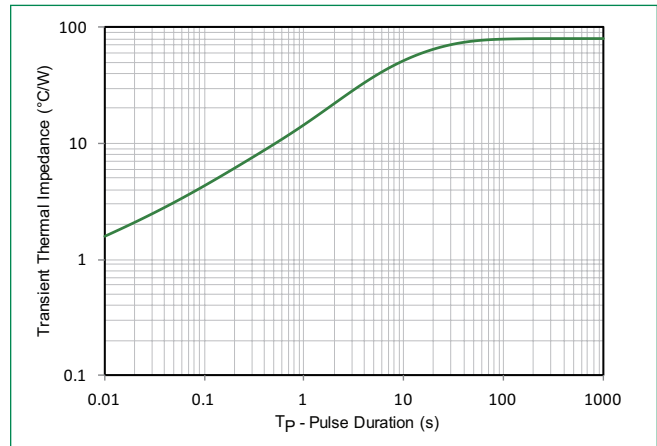

Figure 7 - Maximum Non-Repetitive Forward Surge Current Uni-Directional Only

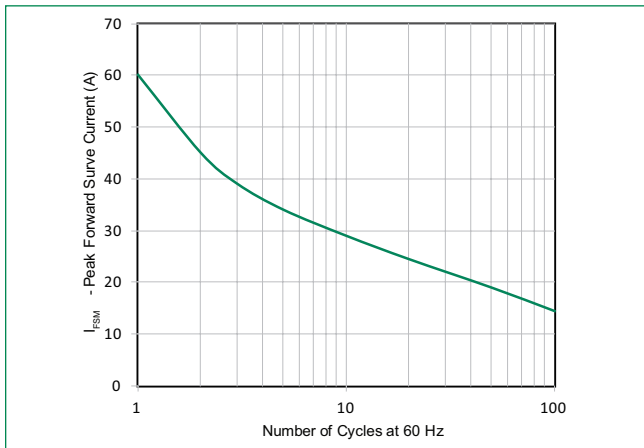
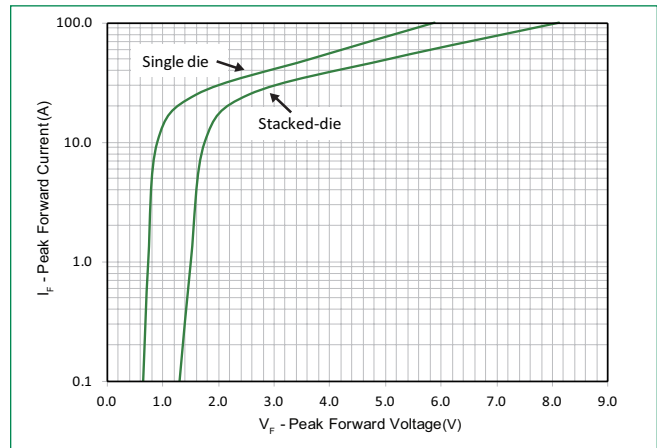
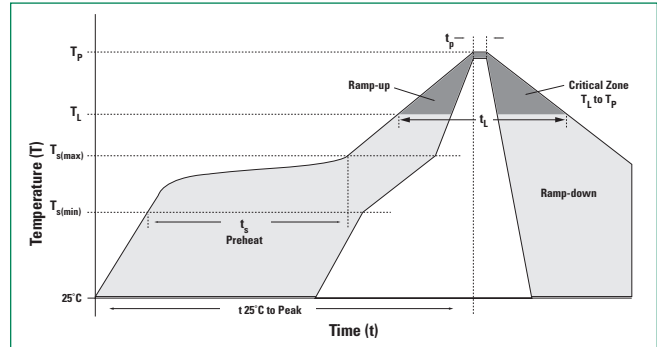

Figure 8 - Peak Forward Voltage Drop vs Peak Forward Current (Typical Values)



Soldering Parameters

Reflow Condition		Lead-free assembly
Pre Heat	- Temperature Min ($T_{s(min)}$)	150°C
	- Temperature Max ($T_{s(max)}$)	200°C
	- Time (min to max) (t_s)	60 – 120 secs
Average ramp up rate (Liquidus Temp (T_L) to peak)		3°C/second max
$T_{s(max)}$ to T_L - Ramp-up Rate		3°C/second max
Reflow	- Temperature (T_L) (Liquidus)	217°C
	- Time (min to max) (t_L)	60 – 150 seconds
Peak Temperature (T_p)		260 ^{+0/-5} °C
Time within 5°C of actual peak Temperature (t_p)		30 seconds max
Ramp-down Rate		6°C/second max
Time 25°C to peak Temperature (T_p)		8 minutes Max.
Do not exceed		260°C



Flow/Wave Soldering (Solder Dipping)

Peak Temperature :	260°C
Dipping Time :	5 seconds
Soldering :	1 time

Physical Specifications

Weight	0.012oz., 0.3g
Case	JEDEC DO-204AL (DO-41) molded plastic body over passivated junction.
Polarity	Colored band indicates unidirectional component's cathode end
Terminal	Matte Tin axial leads, solderable per JESD22-B102.

Environmental Specifications

High Temp. Storage	JESD22-A103
HTRB	JESD22-A108
Temperature Cycling	JESD22-A104
H3TRB	JESD22-A101
RSH	JESD22-B106

Dimensions

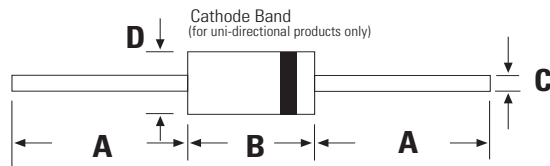

DO-204AL (DO-41)

Dimensions	Inches		Millimeters	
	Min	Max	Min	Max
A	1.000	-	25.40	-
B	0.160	0.205	4.10	5.20
C	0.028	0.034	0.71	0.86
D	0.080	0.107	2.00	2.70

Part Numbering System

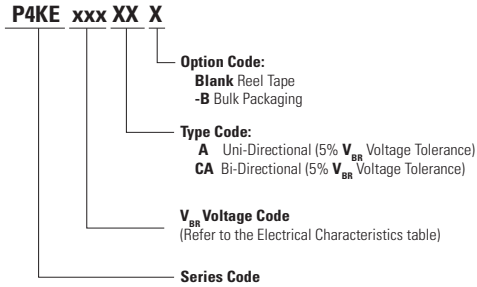

Part Marking System

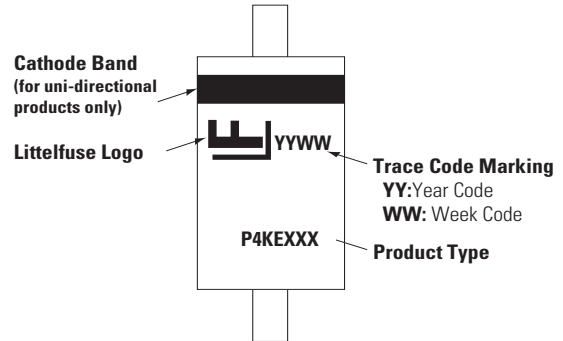

Packaging

Part Number	Component Package	Quantity	Packaging Option	Packaging Specification
P4KExxxXX	DO-204AL	5000	Tape & Reel	EIA STD RS-296
P4KExxxXX-B	DO-204AL	500	BOX	Littelfuse Spec.

Tape and Reel Specification

