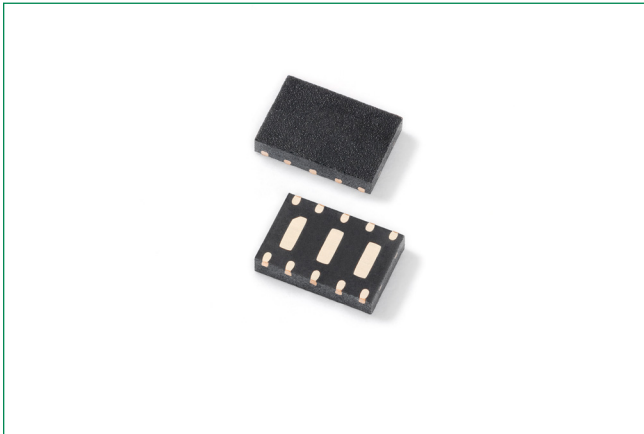
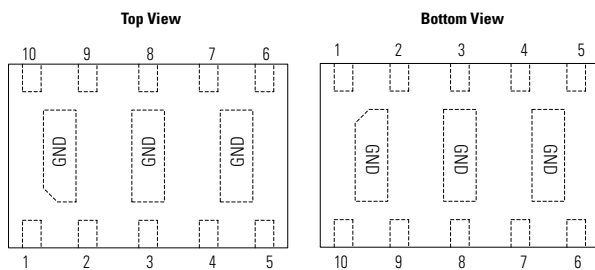
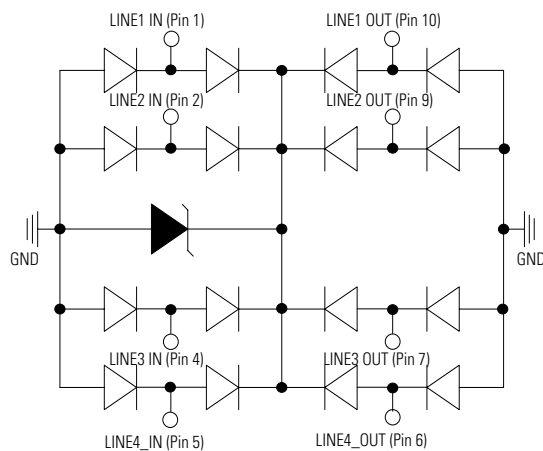

SP2574NUTG

2.5V 40A Diode Array

OBSOLETE DATE: 12/31/2020 PCN/ECN# ESU270-49
REPLACED BY: SP2555NUTG or AQ2555NUTG**Pinout****Note:** PIN3, PIN8 are same potential with GND**Functional Block Diagram****Description**

The SP2574NUTG is a low-capacitance, TVS Diode Array designed to provide protection against ESD (electrostatic discharge), CDE (cable discharge events), EFT (electrical fast transients), and lightning induced surges for high-speed, differential data lines. It's packaged in a μ DFN package (3.0 x 2.0mm) and each component can protect up to 4 channels or 2 differential pairs, up to 40A (IEC 61000-4-5) and up to 30kV ESD (IEC 61000-4-2). The "flow-through" design minimizes signal distortion, reduces voltage overshoot, and provides a simplified PCB design.

The SP2574NUTG with its low capacitance and low clamping voltage makes it ideal for high-speed data interfaces such as 1GbE applications found in notebooks, switches, etc.

Features & Benefits

- ESD, IEC 61000-4-2, ± 30 kV contact, ± 30 kV air
- EFT, IEC 61000-4-4, 40A (5/50ns)
- Lightning, 40A (8/20 μ s as defined in IEC 61000-4-5 2nd Edition)
- Low capacitance of 3.8pF@0V (TYP) per I/O
- Low leakage current of 0.1 μ A (TYP) at 2.5V
- μ DFN-10 package is optimized for high-speed data line routing
- Provides protection for two differential data pairs (4 channels) up to 40A
- Low operating and clamping voltage
- AEC-Q101 qualified

Applications

- 10/100/1000 Ethernet
- WAN/LAN Equipment
- Desktops, Servers and Notebooks
- LVDS Interfaces
- Integrated Magnetics
- Smart TV

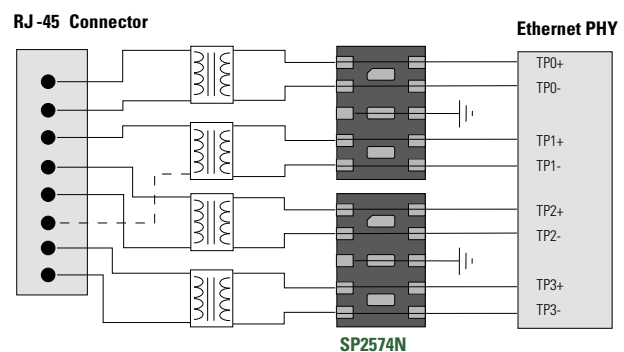
Application Example

Life Support Note:

Not Intended for Use in Life Support or Life Saving Applications

The products shown herein are not designed for use in life sustaining or life saving applications unless otherwise expressly indicated.

SP2574NUTG

2.5V 40A Diode Array

Absolute Maximum Ratings

Symbol	Parameter	Value	Units
I_{PP}	Peak Current ($t_p=8/20\mu s$)	40 ¹	A
P_{PK}	Peak Pulse Power ($t_p=8/20\mu s$)	1000	W
T_{OP}	Operating Temperature	-40 to 125	°C
T_{STOR}	Storage Temperature	-55 to 150	°C

Notes:

1. Rating with 2 pins connected together per suggested diagram (For example, pin1 is connected to pin 10, pin 2 is connected to Pin 9, Pin 4 is connected to pin 7 and pin 5 is connected to pin 6)

Caution: Stresses above those listed in "Absolute Maximum Ratings" may cause permanent damage to the component. This is a stress only rating and operation of the component at these or any other conditions above those indicated in the operational sections of this specification is not implied.

Electrical Characteristics ($T_{OP}=25^{\circ}C$)

Parameter	Symbol	Test Conditions	Min	Typ	Max	Units
Reverse Standoff Voltage	V_{RWM}	$I_R \leq 1\mu A$			2.5	V
Reverse Leakage Current	I_R	$V_{RWM} = 2.5V, T = 25^{\circ}C$		0.1	0.5	μA
Breakdown Voltage	V_{BR}	$I_{t1} = 1\mu A$	3.0	3.7	4.5	V
Snap Back Voltage	V_{SB}	$I_H = 1mA$	3.0			V
Clamp Voltage	V_C	$I_{PP} = 1A, t_p = 8/20\mu s$ Any I/O to Ground			4.5	V
		$I_{PP} = 10A, t_p = 8/20\mu s$ Any I/O to Ground			7.5	
		$I_{PP} = 25A, t_p = 8/20\mu s$ Any I/O to Ground			12.0	
		$I_{PP} = 40A, t_p = 8/20\mu s$ Line-to-Line ¹ , two I/O Pins connected together on each line			20.0	
Dynamic Resistance ²	R_{DYN}	TLP, $t_p=100ns$, Any I/O to Ground		0.13		Ω
ESD Withstand Voltage	V_{ESD}	IEC 61000-4-2 (Contact)	± 30			kV
		IEC 61000-4-2 (Air)	± 30			kV
Diode Capacitance	$C_{I/O \text{ to GND}}$	Between I/O Pins and Ground $V_R = 0V, f = 1MHz$		3.8	5.0	pF
	$C_{I/O \text{ to I/O}}$	Between I/O Pins $V_R = 0V, f = 1MHz$		1.7		pF

Notes:

1. Rating with 2 pins connected together per suggested diagram (For example, pin1 is connected to pin 10, pin 2 is connected to Pin 9, Pin 4 is connected to pin 7 and pin 5 is connected to pin 6)

2. Transmission Line Pulse (TLP) with 100ns width, 2ns rise time, and average window $t1=70ns$ to $t2=90ns$

Normalized Capacitance vs. Voltage

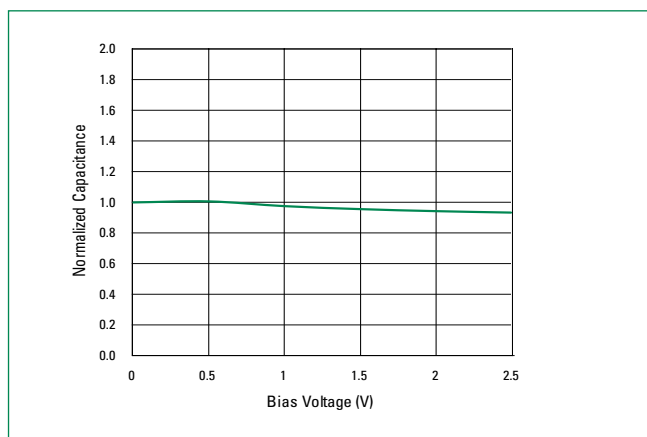

Insertion Loss (S21)

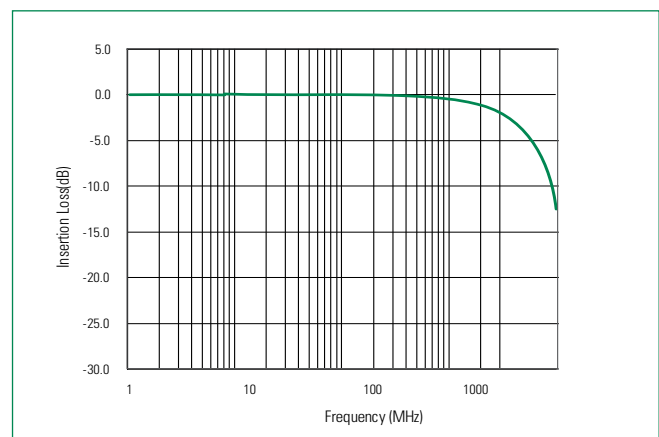

SP2574NUTG

2.5V 40A Diode Array

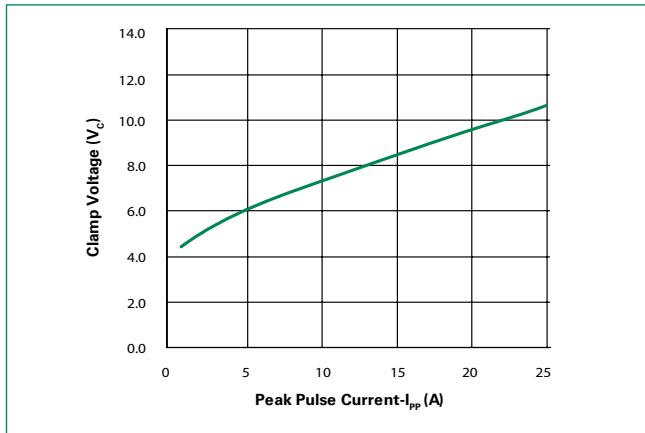
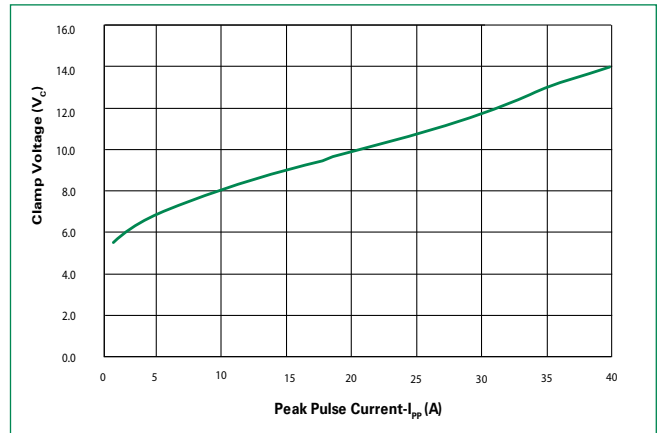
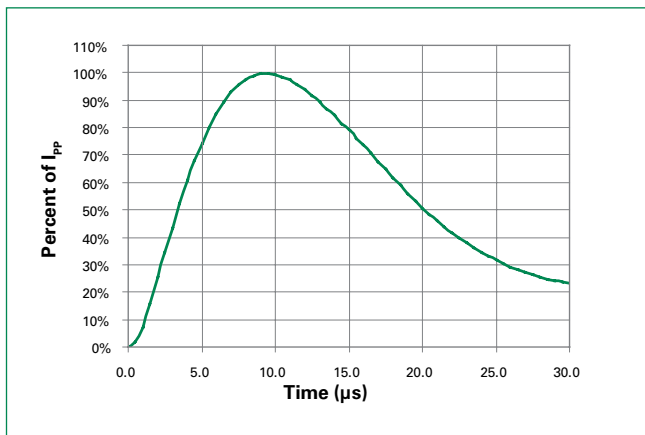
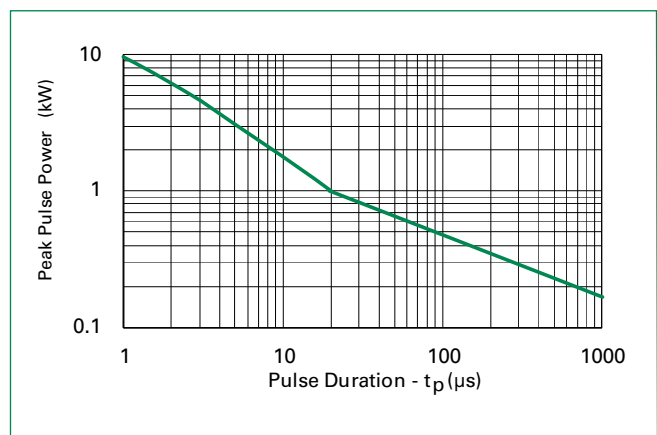
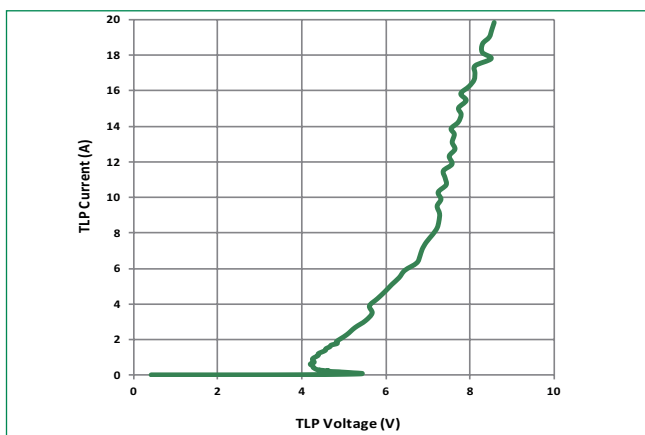
Clamping Voltage vs. IPP (I/O to GND)**Clamping Voltage vs. IPP (Line-to-Line, Two I/O Pins Connected Together)****8/20 μ s Pulse Waveform****Non-Repetitive Peak Pulse Power vs. Pulse Time****Transmission Line Pulse (TLP)**

SP2574NUTG

2.5V 40A Diode Array

Soldering Parameters

Reflow Condition	Pb – Free assembly	
Pre Heat	- Temperature Min ($T_{s(min)}$)	150°C
	- Temperature Max ($T_{s(max)}$)	200°C
	- Time (min to max) (t_s)	60 – 180 secs
Average ramp up rate (Liquidus) Temp (T_L) to peak	3°C/second max	
$T_{s(max)}$ to T_L - Ramp-up Rate	3°C/second max	
Reflow	- Temperature (T_L) (Liquidus)	217°C
	- Temperature (t_L)	60 – 150 seconds
Peak Temperature (T_p)	260 ^{+0/-5} °C	
Time within 5°C of actual peak Temperature (t_p)	20 – 40 seconds	
Ramp-down Rate	6°C/second max	
Time 25°C to peak Temperature (T_p)	8 minutes Max.	
Do not exceed	260°C	

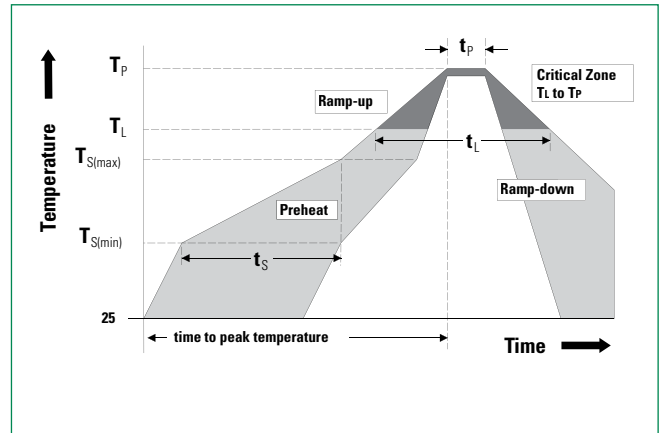

Product Characteristics

Lead Plating	Pre-Plated Frame
Lead Material	Copper Alloy
Lead Coplanarity	0.004 inches(0.102mm)
Substrate material	Silicon
Body Material	Molded Compound
Flammability	UL Recognized compound meeting flammability rating V-0

Ordering Information

Part Number	Package	Min. Order Qty.
SP2574NUTG	μDFN-10 (3.0x2.0mm)	3000

Part Numbering System

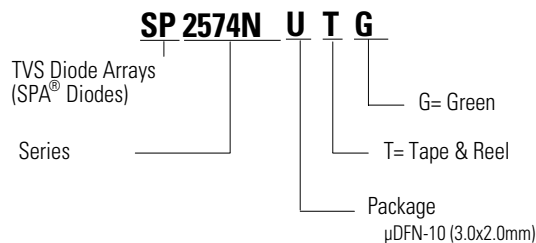

Part Marking System

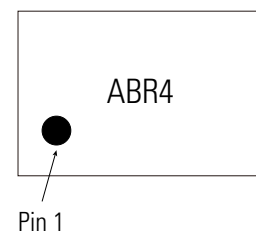

SP2574NUTG

2.5V 40A Diode Array

Package Dimensions — μ DFN-10 (3.0x2.0mm)

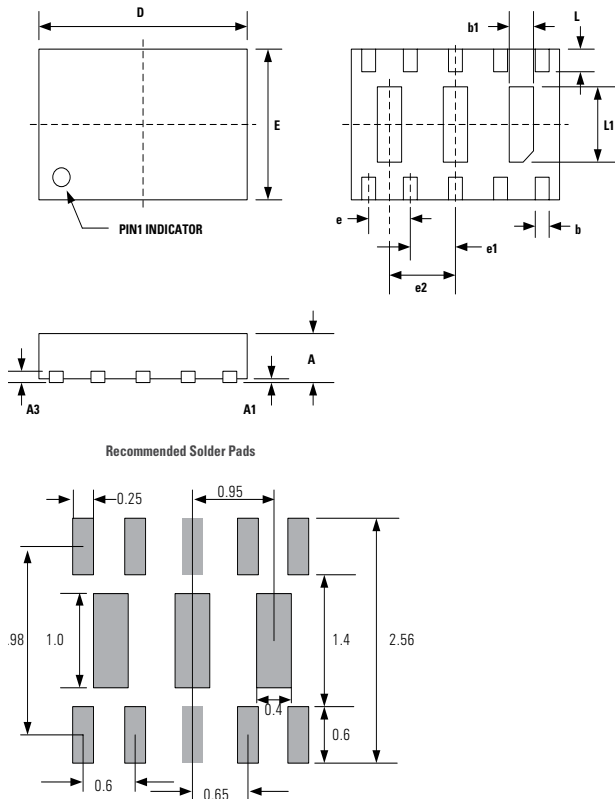

Package	μ DFN-10 (3.0x2.0mm)					
JEDEC	MO-229					
Symbol	Millimeters			Inches		
	Min	Nom	Max	Min	Nom	Max
A	0.50	0.60	0.65	0.020	0.024	0.026
A1	0.00	0.03	0.05	0.000	0.001	0.002
A3	0.15 Ref			0.006 Ref		
b	0.15	0.20	0.25	0.006	0.008	0.010
b1	0.25	0.35	0.45	0.010	0.014	0.018
D	2.90	3.00	3.10	0.114	0.118	0.122
E	1.90	2.00	2.10	0.075	0.079	0.083
e	0.60 BSC			0.024 BSC		
e1	0.65 BSC			0.026 BSC		
e2	0.95 BSC			0.037		
L	0.25	0.30	0.35	0.010	0.012	0.014
L1	0.95	1.00	1.05	0.037	0.039	0.041

Notes :

- All dimensions are in millimeters
- Dimensions include solder plating.
- Dimensions are exclusive of mold flash & metal burr

Tape & Reel Specification — μ DFN-10 (3.0x2.0mm)

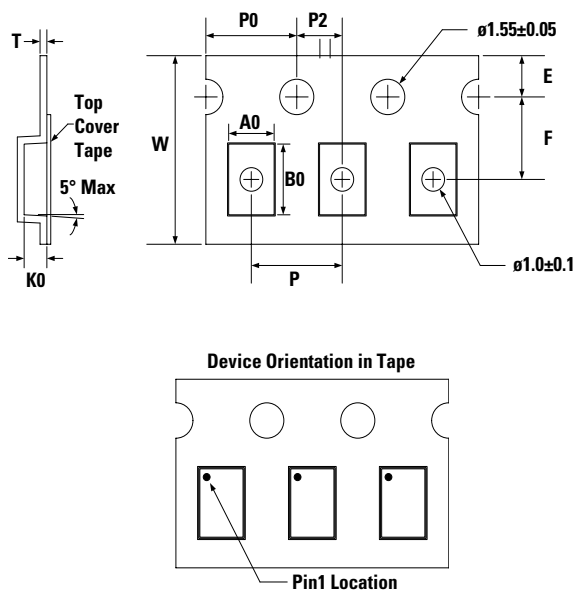

Package	μ DFN-10 (3.0x2.0mm)
Symbol	Millimeters
A0	2.30 +/- 0.10
B0	3.20 +/- 0.10
E	1.75 +/- 0.10
F	3.50 +/- 0.05
K0	1.0 +/- 0.10
P	4.00 +/- 0.10
P0	4.00 +/- 0.10
P2	2.00 +/- 0.10
T	0.3 +/- 0.05
W	8.00 + 0.30 /- 0.10

Disclaimer Notice - Information furnished is believed to be accurate and reliable. However, users should independently evaluate the suitability of and test each product selected for their own applications. Littelfuse products are not designed for, and may not be used in, all applications. Read complete Disclaimer Notice at <http://www.littelfuse.com/disclaimer-electronics>.